

Bulkhead Female Connector__FT x NPT(F)

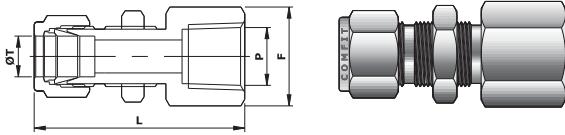

COMFIT PRODUCT CODE	TUBE OD (ØT)	NPT Female Pipe Size (P)	LENGTH (L)	HEX (F)
	(Inches)			
2-CBFCD-2N	1/8	1/8	1.76	9/16
4-CBFCD-2N	1/4	1/8	1.85	5/8
4-CBFCD-4N	1/4	1/4	2.04	3/4
5-CBFCD-2N	5/16	1/8	1.96	11/16
5-CBFCD-8N	5/16	1/2	2.38	1-1/16
6-CBFCD-4N	3/8	1/4	2.17	3/4
8-CBFCD-6N	1/2	3/8	2.43	7/8
8-CBFCD-8N	1/2	1/2	2.62	1
12-CBFCD-12N	3/4	3/4	2.90	1-1/4
16-CBFCD-16N	1	1	3.68	1-5/8

Bulkhead Female Connector__MT x NPT(F)

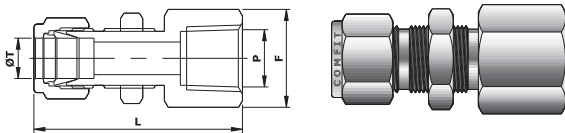

COMFIT PRODUCT CODE	TUBE OD (ØT)	NPT Female Pipe Size (P)	LENGTH (L)	HEX (F)
	(mm)	(Inches)	(mm)	
6M-CBFCD-2N	6	1/8	47.2	16
6M-CBFCD-4N	6	1/4	51.8	19
8M-CBFCD-2N	8	1/8	49.6	17,4
10M-CBFCD-4N	10	1/4	55.2	19
12M-CBFCD-6N	12	3/8	60.9	25
12M-CBFCD-8N	12	1/2	66.5	27

Reducer__FT x Fractional Stub

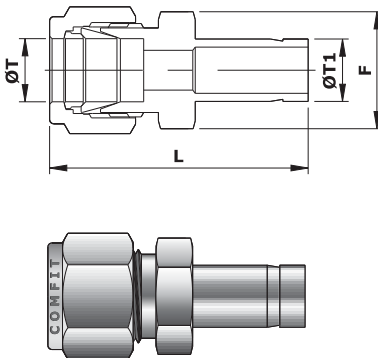

COMFIT PRODUCT CODE	TUBE OD (ØT)	TUBE OD (ØT1)	LENGTH (L)	HEX (F)
	(Inches)			
2-CRD-1S	1/8	1/16	1.14	7/16
2-CRD-2S	1/8	1/8	1.32	7/16
2-CRD-3S	1/8	3/16	1.35	7/16
2-CRD-4S	1/8	1/4	1.42	7/16
2-CRD-6S	1/8	3/8	1.48	7/16
2-CRD-8S	1/8	1/2	1.74	9/16
4-CRD-2S	1/4	1/8	1.45	1/2
4-CRD-3S	1/4	3/16	1.48	1/2
4-CRD-4S	1/4	1/4	1.54	1/2
4-CRD-5S	1/4	5/16	1.57	1/2
4-CRD-6S	1/4	3/8	1.60	1/2
4-CRD-8S	1/4	1/2	1.82	9/16
4-CRD-10S	1/4	5/8	1.89	11/16
4-CRD-12S	1/4	3/4	1.88	7/8
5-CRD-6S	5/16	3/8	1.65	9/16
5-CRD-8S	5/16	1/2	1.87	9/16
6-CRD-4S	3/8	1/4	1.63	5/8
6-CRD-6S	3/8	3/8	1.70	5/8
6-CRD-8S	3/8	1/2	1.91	5/8
6-CRD-10S	3/8	5/8	1.98	11/16
6-CRD-12S	3/8	3/4	1.98	7/8
8-CRD-4S	1/2	1/4	1.77	7/8
8-CRD-6S	1/2	3/8	1.84	7/8
8-CRD-8S	1/2	1/2	2.06	7/8
8-CRD-10S	1/2	5/8	2.12	7/8
8-CRD-12S	1/2	3/4	2.12	7/8
8-CRD-16S	1/2	1	2.37	1-1/16
12-CRD-8S	3/4	1/2	2.15	1-1/16

Reducer__MT x Metric Stub

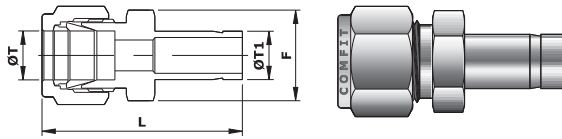

COMFIT PRODUCT CODE	TUBE OD (ØT)	TUBE OD (ØT1)	LENGTH (L)	HEX (F)
	(mm)			
2M-CRD-3MS	2	3	33.5	12
3M-CRD-4MS	3	4	35.0	12
3M-CRD-6MS	3	6	36.1	12
3M-CRD-10MS	3	10	38.4	14
4M-CRD-6MS	4	6	37.1	12
6M-CRD-3MS	6	3	36.9	14
6M-CRD-8MS	6	8	39.9	14
6M-CRD-10MS	6	10	40.7	14
6M-CRD-12MS	6	12	46.3	14
6M-CRD-18MS	6	18	49.6	22
8M-CRD-6MS	8	6	40.3	16
8M-CRD-10MS	8	10	42.0	16
8M-CRD-12MS	8	12	47.6	16
10M-CRD-6MS	10	6	42.4	19
10M-CRD-8MS	10	8	43.4	19
10M-CRD-12MS	10	12	49.8	19
10M-CRD-15MS	10	15	51.3	19
10M-CRD-18MS	10	18	51.3	22
12M-CRD-6MS	12	6	44.9	22
12M-CRD-8MS	12	8	45.9	22
12M-CRD-10MS	12	10	46.7	22
12M-CRD-16MS	12	16	53.8	22
12M-CRD-18MS	12	18	53.8	22
12M-CRD-20MS	12	20	56.1	22
12M-CRD-22MS	12	22	56.1	25
12M-CRD-25MS	12	25	62.4	27
16M-CRD-12MS	16	12	53.0	25
16M-CRD-18MS	16	18	54.7	25
16M-CRD-20MS	16	20	55.3	25
16M-CRD-25MS	16	25	64.0	27
25M-CRD-16MS	25	16	63.2	30
25M-CRD-18MS	25	18	63.1	35
25M-CRD-20MS	25	20	64.6	35

Port Connector__Two Fractional Stub

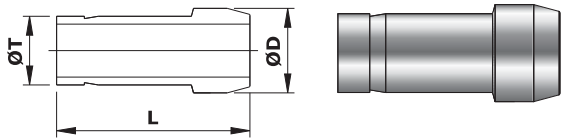

COMFIT PRODUCT CODE	TUBE OD (ØT)	LENGTH (L)	(ØD)
	(Inch)		
2S-CPCD	1/8	0.88	0.24
4S-CPCD	1/4	0.97	0.37
5S-CPCD	5/16	1.02	0.43
6S-CPCD	3/8	1.03	0.50
8S-CPCD	1/2	1.41	0.62
12S-CPCD	3/4	1.47	0.87
16S-CPCD	1	1.89	1.12

Port Connector__Two Metric Stub

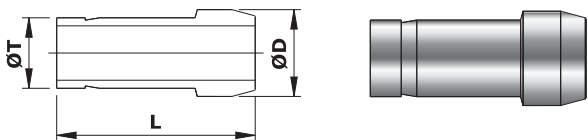

COMFIT PRODUCT CODE	TUBE OD (ØT)	LENGTH (L)	(ØD)
	(mm)		
3MS-CPCD	3	22.2	6.0
6MS-CPCD	6	24.6	9.0
8MS-CPCD	8	25.9	11.0
10MS-CPCD	10	26.1	13.1
12MS-CPCD	12	35.8	15.0
15MS-CPCD	15	37.4	19.0
16MS-CPCD	16	37.4	19.0
25MS-CPCD	25	48.0	28.0

Reducer Port Connector__Two Fractional Stub

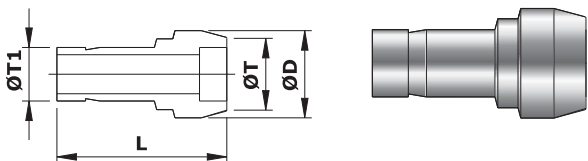

COMFIT PRODUCT CODE	TUBE OD (ØT)	TUBE OD (ØT1)	LENGTH (L)	(ØD)
	(Inch)			
2S-CRPCD-1S	1/8	1/16	0.68	0.24
4S-CRPCD-1S	1/4	1/16	0.71	0.37
4S-CRPCD-2S	1/4	1/8	0.89	0.37
6S-CRPCD-2S	3/8	1/8	0.91	0.50
6S-CRPCD-4S	3/8	1/4	0.93	0.50
8S-CRPCD-4S	1/2	1/4	1.15	0.62
8S-CRPCD-6S	1/2	3/8	1.520	0.62
12S-CRPCD-8S	3/4	1/2	1.49	0.87
16S-CRPCD-8S	1	1/2	1.68	1.12
16S-CRPCD-12S	1	3/4	1.71	1.12

DIMENSIONS FOR REFERENCE ONLY, SUBJECT TO CHANGE.